

BBVA RMBS 3 Fondo de Titulización de Activos

RMBS / Spain

*This pre-sale report addresses the structure and characteristics of the proposed transaction based on the information provided to Moody's as of 25 June 2007. Investors should be aware that certain issues concerning this transaction have yet to be finalised. Upon conclusive review of all documents and legal information as well as any subsequent changes in information, Moody's will endeavour to assign definitive ratings to this transaction. The **definitive** ratings may differ from the **provisional** ratings set forth in this report. Moody's will disseminate the assignment of definitive ratings through its Client Service Desk. This report does not constitute an offer to sell or a solicitation of an offer to buy any securities, and it may not be used or circulated in connection with any such offer or solicitation.*

Estimated Closing Date

July 2007

Lead Analyst

Alberto Barbáchano
Assistant Vice President – Analyst
+34 91 702-6601
Alberto.Barbachano@moodys.com

Backup Analyst

Maria Turbica
Associate Analyst
+34 91 702-6684
Maria.Turbica@moodys.com

Investor Liaison

New York
Brett Hemmerling
Investor Liaison Specialist
+1 212 553-4796
Brett.Hemmerling@moodys.com

Client Service Desk

London: +44 20 7772-5454
Madrid: +34 91 414-3161
clientservices.emea@moodys.com

Monitoring

monitor.rmbs@moodys.com

Website

www.moodys.com

DEFINITIVE RATINGS

Class	Rating	Amount (million)	% of Notes	Legal Final Maturity	Coupon
A1	Aaa	€1,200.00	40.00	Feb. 60	3mE + [·]%
A2	Aaa	€595.50	19.85	Feb. 60	3mE + [·]%
A3	Aaa	€960.00	32.00	Feb. 60	3mE + [·]%
B	A1	€156.00	5.20	Feb. 60	3mE + [·]%
C	Baa3	€88.50	2.95	Feb. 60	3mE + [·]%
Total		€3,000.00	100.00		

The ratings address the expected loss posed to investors by the legal final maturity. In Moody's opinion the structure allows for timely payment of interest and ultimate payment of principal at par on or before the rated final legal maturity date. Moody's ratings address only the credit risks associated with the transaction. Other non-credit risks have not been addressed, but may have a significant effect on yield to investors.

OPINION

Strengths of the Transaction

- Strong Swap to hedge interest rate risk in the transaction, securing weighted average interest rate of the notes plus 65 bps excess spread and covering the servicing fee
- Excess spread trapping through a 12-month “artificial write-off” mechanism
- 9.00% of the portfolio corresponds to protected life time employed (Spanish civil servant)
- Only 1.90% of the portfolio corresponds to second home
- No second-lien products being included
- 100% of the loans are paid via direct debit on a monthly basis
- All the loans paid through monthly installments
- At closing no loans will carry any amounts more than 30 days past due

Weaknesses and Mitigants

- 86% of the loans have an LTV over 80%, which leads to a higher expected default frequency and more severe losses.
- All of the loans are subject to an interest rate Cap, however the risk is eliminated by the swap
- Servicing fee paid senior in the waterfall, but fully funded through the swap payments received by the Fondo
- Higher % of risky products than its predecessors (see particular characteristic of the loans below)



- Flexible product (payment holidays, possibility of enjoying an automatic reduction of the margin, maturity increase). Some of these peculiarities of the loans could lead to a higher default frequency; however the reserve fund and the subordination have been sized accordingly to account for these risks. Additionally the swap eliminates any risk related to the reduction of the margin and holiday payments.
- Pro-rata amortisation of B and C Series of Notes leads to reduced credit enhancement for the senior series in absolute terms. This is mitigated by strict triggers which terminate the pro-rata amortisation of the notes should the performance of the transaction deteriorate.
- The deferral of interest payments on Series B and C benefits the repayment of the series senior to each of them, but increases the expected loss on Series B, and C themselves.

STRUCTURE SUMMARY

Issuer:	BBVA RMBS 3 Fondo de Titulización de Activos
Structure Type:	Senior/Mezzanine/Subordinated/Reserve Fund
Seller/Originator:	Banco Bilbao Vizcaya Argentaria (BBVA) (Aa1/P-1)
Servicer:	Banco Bilbao Vizcaya Argentaria (BBVA) (Aa1/P-1)
Back-up Servicer:	N/A
Interest Payments:	Quarterly in arrears on each payment date
Principal Payments:	Pass-through on each payment date
Credit Enhancement/Reserves:	Excess spread per annum Reserve fund Subordination
Liquidity Facility:	N/A
Hedging:	Interest rate swap to cover interest rate risk and guaranteeing 65 bppa of excess and covering the servicing fee
Principal Paying Agent:	Banco Bilbao Vizcaya Argentaria (BBVA) (Aa1/P-1)
Management Company:	Europea de Titulización S.G.F.T. S.A (EdT)
Arranger/Lead Manager:	BBVA,

COLLATERAL SUMMARY

Loan Amount:	3,671,531,544
Loans Count:	20,566
Pool Cut-off Date:	25 June 2007
WA Original LTV:	89.18%
WA Current LTV:	87.72%
WA Seasoning:	1.04
WA Remaining Term:	32.99
Interest Rate:	4.73%
Geographic Diversity:	Catalonia 24.02%, Madrid 14.54%, Andalusia 15.58%
Loan Purpose:	The loans have been granted to finance the purchase residential homes located in Spain. All the properties are already constructed
Average Loan Size:	178,524

TRANSACTION SUMMARY

Plain vanilla structure

This transaction consists of the securitisation of a pool of first-lien mortgages originated and serviced by BBVA, one of the biggest Spanish banks with a proven track record in the securitisation market. BBVA 3 Fondo de Titulización de Activos (hereafter referred to as the “Fondo”) is the third RMBS securitisation by BBVA.

The purpose of the transaction is to obtain liquidity and remove the credit risk linked to mortgages on BBVA’s balance sheet. In this transaction, BBVA will sell a portfolio of mortgage loans to the *Fondo*, a special purpose vehicle (SPV). The *Fondo* will in turn issue five Series of notes to fund the purchase of the mortgage loan portfolio.

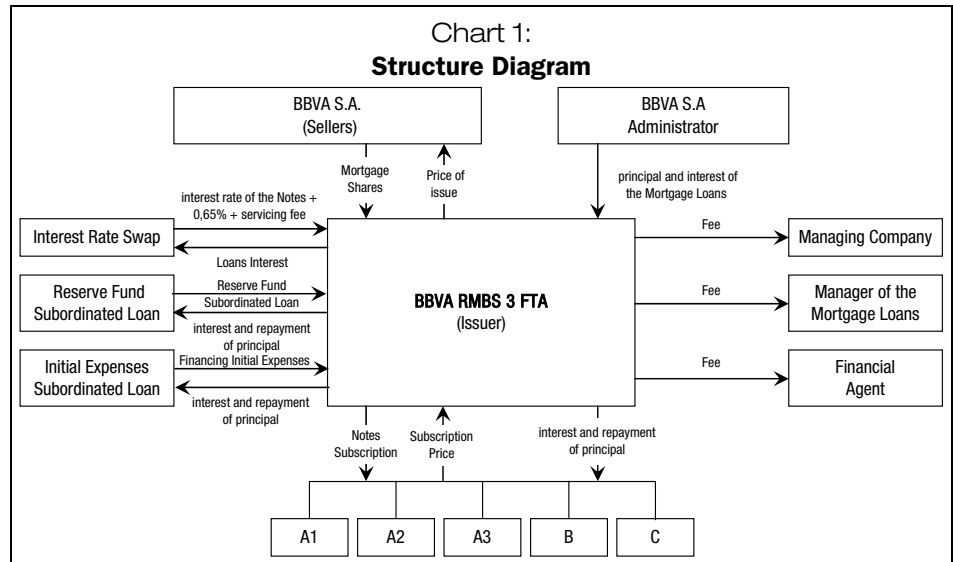

The Fondo will issue six Series of notes to finance the purchase of the loans (at par):

- A subordinated Series C, rated (P)**Baa3**
- A mezzanine Series B, rated (P)**A1**
- A senior Class A composed of three (P)**Aaa** rated series: a subordinated Series A3 a mezzanine Series A2 and a senior Series A1

STRUCTURAL AND LEGAL ASPECTS

Borrower payments swept into BBVA GIC account every week

The treasury account will be held at BBVA. The proceeds from the loans, amounts received under the swap agreement and the reserve fund will be deposited in the treasury account.

Moody’s has set up some triggers in order to protect the treasury account from a possible downgrade of BBVA’s short-term rating. Should BBVA’s short-term rating fall below **P-1**, it will have to perform one of the following actions in the indicated order of priority within 30 days:

- Find a suitably rated guarantor or substitute.
- Collateralise its payment obligations under the treasury account in an amount sufficient to maintain the then current rating of the notes.
- Invest the outstanding amount of the treasury account in securities issued by a **P-1**-rated entity.

BBVA guarantees an annual yield of the amounts deposited in the treasury account equal to the index reference rate of the notes less 10 bppa

Interest rate swap guaranteeing the interest rate of the notes plus 65 bppa of excess spread and covering the servicing fee

According to the swap agreement entered into between the Fondo and BBVA, on each payment date:

- The Fondo will pay the amount of interest actually received from the loans; and
- BBVA will pay the sum of (1) the weighted average coupon on the notes plus 65 bppa, over a notional calculated as the daily average outstanding amount of the loans not more than 90 days in arrears and (2) the servicing fee due on such payment date

The excess spread thus provided through the swap agreement constitutes the first layer of protection for investors.

In the event of BBVA's long-term rating being downgraded below A2 or P-1, within 30 days BBVA will have to (1) collateralise its obligations under the swap in an amount sufficient to maintain the current rating of the notes or (2) find a suitably rated guarantor or substitute.

Reserve fund to help the Fondo meet its payment obligations

The second layer of protection against losses is a reserve fund provided by BBVA. It will be used to cover potential shortfalls on interest or principal on an ongoing basis.

At every point in time, the amount requested under the reserve fund will be the lesser of the following amounts:

- 1.30 % of the initial balance of the notes

The higher of the following amounts:

- 2.60% of the outstanding balance of the notes
- 0.80% of the initial balance of the notes

The amount requested under the reserve fund will not be reduced on any payment date on which either of the following scenarios occurs:

- The arrears level (defined as the percentage of non-written-off loans that are more than 90 days in arrears) exceeds 1.00%.
- The reserve fund will not be funded at its required level on the current payment date.

Additionally the reserve fund will not amortise during the first 36 months of the life of the transaction.

Class A amortisation

Until the payment date on which the initial amount of Series B, and C exceeds 10.40%, and 5.90%, respectively, of the outstanding amount under all series, the amount retained as principal due will be used for the repayment of the following items in the indicated order of priority:

- 1) Amortisation of Series A1
- 2) Amortisation of Series A2
- 3) Amortisation of Series A3

Nevertheless, the amount retained as principal due will be allocated pro-rata between Series A1, Series A2 and Series A3, if the outstanding amount of performing loans (including loans up to 90 days in arrears) divided by the aggregated outstanding amount of Series A1, A2, and A3 is lower than 1.2.

Series B and C amortisation

- The Series B notes will start amortising pro rata with the Class A notes when they represent 10.40% of the outstanding balance under Class A, Series B and C.
- The Series C notes will start amortising pro rata with the Class A and Series B notes when they represent 5.90% of the outstanding balance under Class A, Series B and C.

Pro-rata amortisation entails greater risk than fully sequential transactions, given that the credit enhancement decreases in absolute terms. The risks introduced by pro-rata amortisation are mitigated by the following triggers:

Table 1:

Series B	Series C
The arrears level (loans more than 90 days in arrears, excluding the written off loans) exceeds 1.25%	The arrears level (loans more than 90 days in arrears, excluding the written off loans) exceeds 1.00%
The reserve fund is not funded at the required level	
The loan balance is less than 10% of the initial loan balance	

The Pre-enforcement Waterfall

On each quarterly payment date, the *Fondo's* available funds (principal received from the asset pool, the Reserve Fund, amounts received under the swap agreement and interest earned on the transaction accounts) will be applied in the following simplified order of priority:

- 1) Cost
- 2) Servicing fees
- 3) Any amount due under the swap agreement (except termination payments if BBVA defaults under the swap agreement)
- 4) Interest payment to Series A1, A2 and A3
- 5) Interest payment to Series B notes (if not deferred)
- 6) Interest payment to Series C notes (if not deferred)
- 7) Retention of an amount equal to the principal due under the notes
- 8) Interest payment to Series B notes (if deferred)
- 9) Interest payment to Series C notes (if deferred)
- 10) Replenishment of the reserve fund
- 11) Termination payments under the swap agreement upon default of BBVA
- 12) Junior expenses

Principal due to the notes incorporates a 12-month artificial "write-off"

The transaction's structure benefits from an "artificial write-off" mechanism. This mechanism is implicit in the definition of the principal due under the notes, which is calculated as the difference between (1) the outstanding amount of the notes and (2) the outstanding amount of the non-written-off loans (the "written-off loans" being defined as those loans with any amount due but unpaid for more than 12 months, or earlier if the loan is in a foreclosure procedure).

Interest Deferral trigger based on default

The payment of interest on Series B and C notes will be brought to a more junior position if, on any payment date, the following criteria are met:

Table 2:

Series B:	The accumulated amount of written-off loans is higher than 12.5% of the initial amount of the assets pool Class A is not fully redeemed
Series C:	The accumulated amount of written-off loans is higher than 10.0% of the initial amount of the assets pool Class A and Series B are not fully redeemed

COLLATERAL

As of June 2007, the portfolio comprised 20,566 loans, representing a provisional portfolio of €3,671,531,544. The loans are first-lien mortgages on residential properties contracted by individuals located in Spain. All the properties on which the mortgage security has been granted are covered by property damage and fire insurance. At closing date there are no loans more than 30 days in arrears. The average loan is €178,524.

Chart 2:
Portfolio Breakdown by LTV

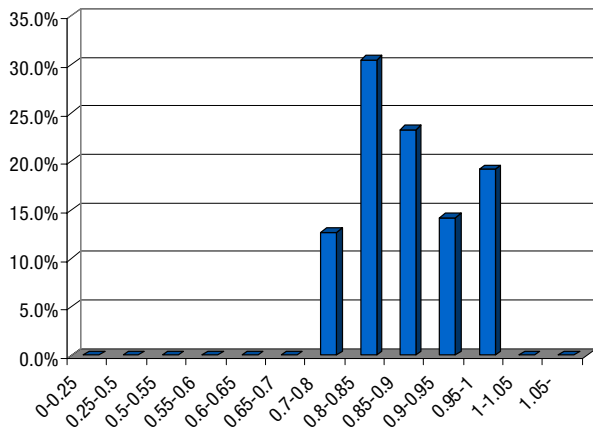

Chart 3:
Portfolio Breakdown by Region

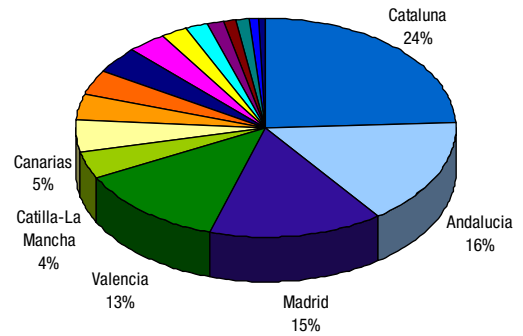

Chart 4:
Portfolio Breakdown by Occupancy Type

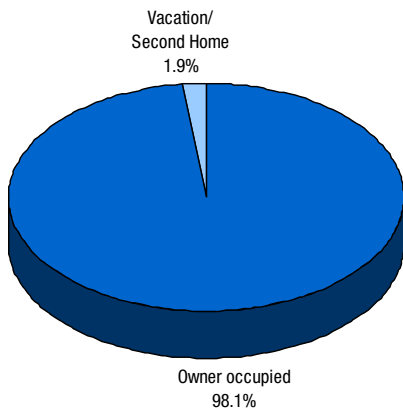

Chart 5:
Portfolio Breakdown by Employment Data

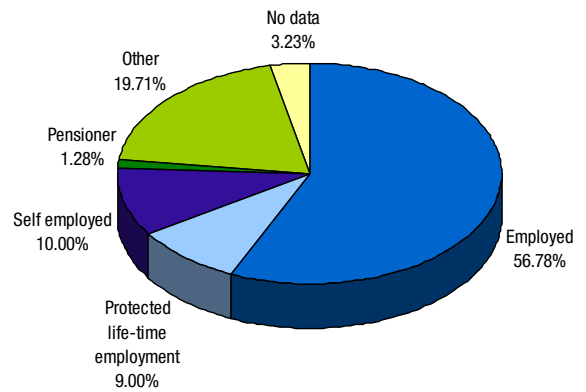

Chart 5:
Portfolio Breakdown by Maturity

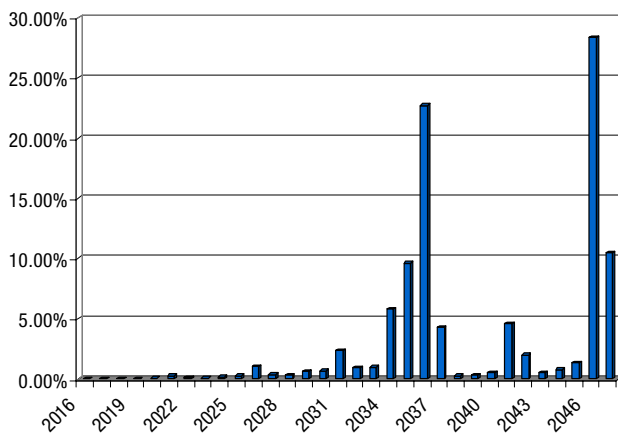
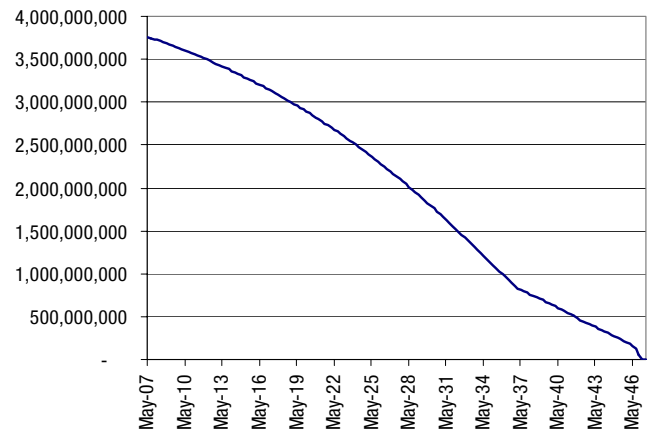

Chart 6:
Real Amortisation Profile 0% CPR



- The purpose of the mortgage loans is the acquisition of residential properties.
- 100% first lien mortgages
- The loans have been originated between 2003 and February 2007, with a weighted average seasoning of 1.04 years and a weighted average remaining term of 32.99 years.
- The original WALTV is 89.18%. The current weighted average LTV is 87.72%. Maximum LTV in portfolio 100%
- 100% of the loans are linked to floating interest rate.

- Only 1.90% of the portfolio corresponds to second home properties.
- 9.00% of the portfolio corresponds to protected life time employed,
- 100% of the portfolio corresponds to residents in Spain
- The top 20 debtors represent 0.31% of the portfolio
- 100% of the loans are paid via direct debit on a monthly basis
- Largest maturity 10-October-2056 (assuming the maximum allowed maturity)

Particular Characteristics of the Loans

- 75.23% of the debtors have the possibility of enjoying an automatic reduction in their margin or changing to a fix interest rate or viceversa (fixed to variable) in cases where they have been cross-sold other BBVA products (e.g. insurance).
- 82.32% of the debtors will have the option of enjoying holiday payments, during which neither principal nor interest are paid. Unpaid interest is capitalized at the end of the grace period.
 - No more than 2 instalments can be granted in a year
 - No more than 10 instalments can be granted during the life of the loan
- For 68.30% of the debtors - the last instalment of the loan represents 10%/30% of loan. However only 21% of the debtors had exercised this option when the loan was originated.
- Although 82.32% of the portfolio can increase the maturity of the loans, it is important to mention that for 54.30% of the loans (1) maturity was increased to the maximum allowed when they were originated or (2) maturity can not be extended due to the age limitation (age + loan term < 70 years). Therefore, the maturity of these loans is lower than 40 years.
- Payment holidays or maturity extension can only be granted if the following conditions are met:
 - 1) The loan is not in arrears
 - 2) Previous notification to the originator by the debtor
 - 3) Always granted subject to BBVA's approval, it is not automatic, BBVA will re-analyse the situation of the debtor.
 - 4) The maximum maturity of the loan can be 40 years or lower if the debtor is closer to 70 years old (age + loan term < 70 years). Example:
 - Debtor is 30 year old maximum maturity is 40 (30 + 40 < 70)
 - Debtor is 50 years old maximum maturity is 20 (50 + 20 < 70)
 - Debtor is 60 years old maximum maturity is 10 (50 + 10 < 70)

Limitations on the renegotiation of the loan

Any renegotiation of the terms and conditions of the loans is subject to the management company's approval. Exceptionally, the management company authorises BBVA to renegotiate the interest rate or maturity of the loans without requiring its approval. However, BBVA will not be able to extend the maturity of any loan beyond 31/10/2056. Moreover, the renegotiation of the maturity of the loans is subject to various conditions, of which the following are the most significant:

- 1) The total initial amount of loans on which the maturity has been extended cannot be greater than 10% of the initial amount of the pool.
- 2) The frequency of payments cannot be decreased.
- 3) The amortisation profile cannot be modified.

Additionally BBVA is not allowed to renegotiate any interest rate of a loan to a margin below 50 bppa

ORIGINATOR, SERVICER AND OPERATIONS REVIEW

BBVA, the second-largest financial group in Spain with a strong focus in the Spanish retail segment, is the originator and servicer of the asset pool

With total assets amounting to €403 billion in September 2006, Banco Bilbao Vizcaya Argentaria, S.A. (BBVA, rated **Aa1/P-1/B**) is the second-largest financial group in Spain after Santander Central Hispano (Santander). Excluding international operations, however, BBVA is Spain's largest financial group with market shares of loans and deposits at around 13% each followed closely by Santander and La Caixa (rated, **Aa1/P-1/B**) with nationwide market shares of about 10% each.

BBVA is also the leading domestic institution in the pension fund business, with an 18.56% market share (48% larger than the next player). In mutual funds, the group is Spain's second-largest player with a market share of 17% at the end of September 2006. In the insurance business, BBVA Seguros ranks number eight by life insurance premiums and a 6% market share. These solid positions are achieved with a 10% share of all branches in the Spanish market. In Spain, BBVA operates through a network of 3,631 branches and 31,230 employees and 5,000 ATMs.

Retail Spain and Portugal business continues to show solid performance as reflected in the 11% y-o-y increase in net profits at the end of September 2006 underpinned by a 12.8% rise in pre-provision income and 9.3% in operating income. Strong business growth is the main driver of this performance, offsetting lower net interest margins that stood at 2.48% compared to 2.66% at the end of September 2005 and 2.55% in June 2006. Aside from mortgage lending, other business segments are catching up, underpinned by the implementation of focused strategies on both the individual and SME segments. Going forward, the sustainability of this improvement will largely depend not only on the economic scenario - prospects for the Spanish economy are favourable for 2007 - and future development of interest rates, but also on the continued success of the bank's strategy with regard to the achievement of enhanced recurring revenues.

Servicer

BBVA will act as servicer of the loans, and will transfer the proceeds from the loans to the treasury account on a weekly basis.

In the event of BBVA being declared bankrupt, failing to perform its obligations as servicer or being affected by a deterioration in its financial situation, either it or the management company will have to designate a new suitable institution as guarantor of BBVA's obligations under the servicing agreement or even as new servicer.

Moody's believes that BBVA is capable of fulfilling its servicing obligations in the transaction.

Likewise, the management company may require BBVA, upon an insolvency process or because the management company considers it appropriate, to notify the transfer of the loans to the Fondo to the relevant debtors. Should the relevant originator fail to comply with this obligation within 5 business days, the notification would then be carried out by the management company.

Paying Agent

BBVA will act as paying agent of the *Fondo*. In the event of BBVA's short-term rating falling below **P-1**, it will within 30 days have to be replaced in its role of paying agent by a suitably rated institution.

EdT

Europea de Titulización is a company with substantial experience in the Spanish securitisation market. Its obligations within the structure are guaranteed by its shareholders, with respect to their proportion of the holding. Banco Bilbao Vizcaya Argentaria (BBVA) accounts for 83% of the capital of the *gestora* (trustee). The remainder is owned by 15 institutions, including JP Morgan (4%), Caja de Ahorros del Mediterráneo (1.54%), Bankinter (1.53%), Barclays Bank (1.53%) and Citibank España (1.53%). Currently Europea de Titulización carries out the management of 65 securitisation funds.

MOODY'S ANALYSIS

Moody's used a lognormal approach

The first step in the analysis is to determine a loss distribution for the pool of mortgages to be securitised. Due to the high volume of loans and supporting historical data, Moody's uses a continuous distribution model to approximate the loss distribution: lognormal distribution.

In order to determine the shape of the curve, two parameters are needed: the expected loss and the volatility associated with this expected loss. These parameters are derived from the Moody's Individual Loan Analysis ("MILAN") model.

In order to extrapolate expected losses for the loan pool, Moody's has compared the underwriting criteria of the originators with those of other mortgage originators in Spain.

Moody's thus determines a number representing the enhancement that would be required for a pool of mortgages to obtain a 'Aaa' rating under highly stressed conditions. This credit enhancement number (the "Aaa CE" number) is obtained by means of a loan-by-loan model.

The Aaa CE number is determined by using MILAN, Moody's loan-by-loan model for rating RMBS transactions

The "MILAN" model looks at each loan in the pool individually and, based on its individual characteristics such as LTV or other identified drivers of risk, computes a benchmark CE number. This number assumes stressed recovery rates (through house price decline), interest rates and costs of foreclosure, as well as a stressed recovery time. The weighted average benchmark CE number is then adjusted according to the positive and negative characteristics of each loan and to those of the pool as a whole, in order to produce the "Aaa CE" number.

The "Aaa CE" number and the Expected Loss Number form the basis of Rating Committee discussions and are used to derive the lognormal distribution of the pool losses.

The standard deviation of the distribution is found by setting the probability of a loss greater than the expected loss that is consistent with the Idealised Expected Loss target of the "Aaa CE" number.

MARCO, Moody's cash-flow model, is used to assess the impact of the structural features of RMBS transactions

Once the loss distribution of the pool under consideration has been computed, a cash flow model, Moody's Analyser of Residential Cash-Flows ("MARCO"), is used to assess the impact of structural features of the transaction, such as the priorities of interest and principal, and the related triggers, swap features and excess margins, liquidity mechanisms and the value of excess spread.

The sum of the loss experienced per note Class in each scenario, weighted by the probability of such loss scenarios, will then determine the expected loss on each tranche and hence the rating, in line with Moody's target losses for each rating category.

RATING SENSITIVITIES AND MONITORING

Europea de Titulización will, in its capacity as management company, prepare quarterly monitoring reports on the portfolio and on payments to the notes. These reports will detail the amounts received by the issuer during each collection period and will provide portfolio data.

Moody's will monitor the transaction on an ongoing basis to ensure that its transaction continues to perform in the manner expected, including checking all supporting ratings and reviewing periodic servicing reports. Any subsequent changes in the rating will be publicly announced and disseminated through Moody's Client Service Desk.

RELATED RESEARCH

Special Reports

- Introducing Moody’s Arrears Index for Spanish Mortgage-Backed Securities, March 2002 (SF12700)
- Moody’s Spanish RMBS Arrears Index: Delinquency Levels Remained Persistently Low in 2002 But Are Likely To Rise Given Weakening Global Economy And Factors Affecting Homeowners’ Indebtedness, May 2003 (SF21607)
- Structural Features in the Spanish RMBS Market Artificial Write-Off Mechanisms: Trapping the Spread, January 2004 (SF29881)

Performance Review

- Spanish RMBS Q3 2006 Performance Review, February 2007 (SF91595)

Rating Methodologies

- Moody’s Approach to Rating Spanish RMBS: The “MILAN” model, March 2005 (SF49068)

Pre-Sale Reports

- BBVA Consumo 1, April 2006 (SF73189)
- BBVA Consumo 2, November 2006 (SF86960)
- BBVA Autos 1, September 2004 (SF44612)
- BBVA Autos 2, December 2005, (SF65988)
- BBVA Hipotecario 3, May 2005 (SF56207)
- BBVA 3 FTPYME, November 2004 (SF47008)
- BBVA 4 PYME, September 2005 (SF61111)
- BBVA 5 FTPYME, October 2006 (SF83565)
- BBVA 1 RMBS, February 2007 (SF90874)

Performance Overviews

- BBVA Consumo 1
- BBVA Consumo 2
- BBVA Autos 1
- BBVA Autos 2
- BBVA Hipotecario 3
- BBVA 3 FTPYME
- BBVA 4 PYME
- BBVA 5 FTPYME

To access any of these reports, click on the entry above. Note that these references are current as of the date of publication of this report and that more recent reports may be available. All research may not be available to all clients.

SF101877isf

© Copyright 2007, Moody's Investors Service, Inc. and/or its licensors and affiliates including Moody's Assurance Company, Inc. (together, "MOODY'S"). All rights reserved. **ALL INFORMATION CONTAINED HEREIN IS PROTECTED BY COPYRIGHT LAW AND NONE OF SUCH INFORMATION MAY BE COPIED OR OTHERWISE REPRODUCED, REPACKAGED, FURTHER TRANSMITTED, TRANSFERRED, DISSEMINATED, REDISTRIBUTED OR RESOLD, OR STORED FOR SUBSEQUENT USE FOR ANY SUCH PURPOSE, IN WHOLE OR IN PART, IN ANY FORM OR MANNER OR BY ANY MEANS WHATSOEVER, BY ANY PERSON WITHOUT MOODY'S PRIOR WRITTEN CONSENT.** All information contained herein is obtained by **MOODY'S** from sources believed by it to be accurate and reliable. Because of the possibility of human or mechanical error as well as other factors, however, such information is provided "as is" without warranty of any kind and **MOODY'S**, in particular, makes no representation or warranty, express or implied, as to the accuracy, timeliness, completeness, merchantability or fitness for any particular purpose of any such information. Under no circumstances shall **MOODY'S** have any liability to any person or entity for (a) any loss or damage in whole or in part caused by, resulting from, or relating to, any error (negligent or otherwise) or other circumstance or contingency within or outside the control of **MOODY'S** or any of its directors, officers, employees or agents in connection with the procurement, collection, compilation, analysis, interpretation, communication, publication or delivery of any such information, or (b) any direct, indirect, special, consequential, compensatory or incidental damages whatsoever (including without limitation, lost profits), even if **MOODY'S** is advised in advance of the possibility of such damages, resulting from the use of or inability to use, any such information. The credit ratings and financial reporting analysis observations, if any, constituting part of the information contained herein are, and must be construed solely as, statements of opinion and not statements of fact or recommendations to purchase, sell or hold any securities. **NO WARRANTY, EXPRESS OR IMPLIED, AS TO THE ACCURACY, TIMELINESS, COMPLETENESS, MERCHANTABILITY OR FITNESS FOR ANY PARTICULAR PURPOSE OF ANY SUCH RATING OR OTHER OPINION OR INFORMATION IS GIVEN OR MADE BY MOODY'S IN ANY FORM OR MANNER WHATSOEVER.** Each rating or other opinion must be weighed solely as one factor in any investment decision made by or on behalf of any user of the information contained herein, and each such user must accordingly make its own study and evaluation of each security and of each issuer and guarantor of, and each provider of credit support for, each security that it may consider purchasing, holding or selling.

MOODY'S hereby discloses that most issuers of debt securities (including corporate and municipal bonds, debentures, notes and commercial paper) and preferred stock rated by **MOODY'S** have, prior to assignment of any rating, agreed to pay to **MOODY'S** for appraisal and rating services rendered by it fees ranging from \$1,500 to approximately \$2,400,000. Moody's Corporation (MCO) and its wholly-owned credit rating agency subsidiary, Moody's Investors Service (MIS), also maintain policies and procedures to address the independence of MIS's ratings and rating processes. Information regarding certain affiliations that may exist between directors of MCO and rated entities, and between entities who hold ratings from MIS and have also publicly reported to the SEC an ownership interest in MCO of more than 5%, is posted annually on Moody's website at www.moody's.com under the heading "Shareholder Relations – Corporate Governance – Director and Shareholder Affiliation Policy."